



Boundless Automation™ Unleashed

Media Tech Briefing

October 3, 2023



Our Experts



Claudio Fayad
VP, Technology, Process
Systems & Solutions
Emerson



Erik Lindhjem
VP, Reliability Solutions
Emerson



Kristel Biehler
VP, Life Sciences
Emerson

Emerson Boundless Automation™ Vision

A simplified architecture that drives operational excellence by removing silos

- ✓ Cohesive software platform
- ✓ Spans cloud, edge and field
- ✓ Democratized data
- ✓ Holistic security
- ✓ Broad interoperability
- ✓ Extensibility for innovation
- ✓ Unlimited scalability

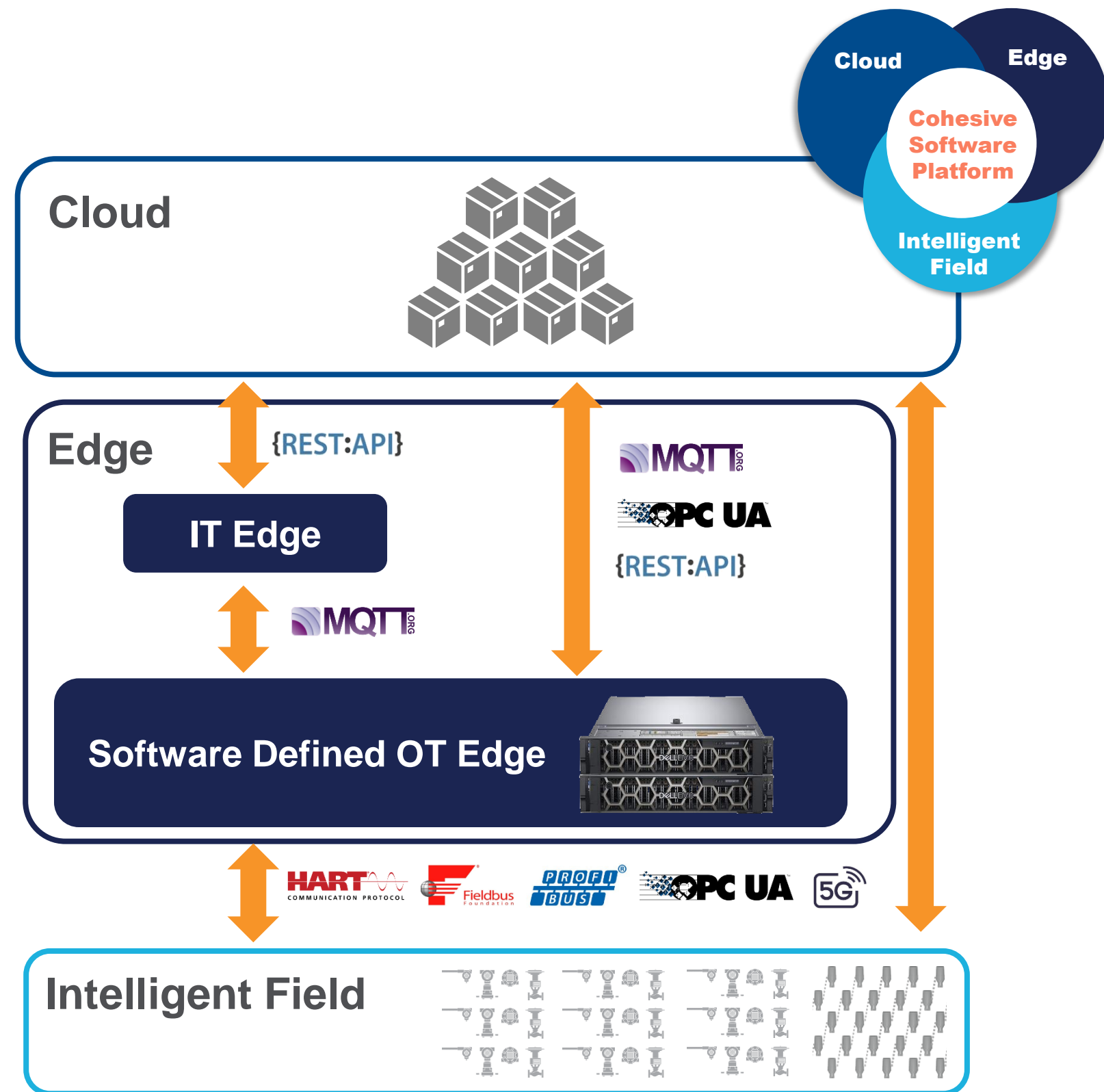

The Leading Name in DCS is Now... The Industry-Leading Automation Platform.

DELTA^V

Our DeltaV brand is evolving. Our foundation in DCS and SIS now expands to include RTUs, SCADA, MES, and Operations Management Software as a ground-breaking Automation Platform. Together, we're redefining the horizons of industrial automation for smarter, safer, optimized, and more sustainable operations.



**Unifying Our
Broad Portfolio**



**Combining Our
Deep Expertise**



**Delivering
Consistent
Experience**



**Shaping the
Future**

2023 Innovations Bring Boundless Automation Vision to Life

Intelligent Field

Profinet and APL

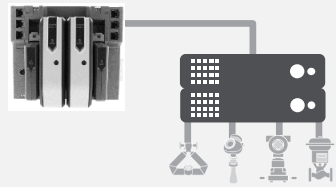

DeltaV IO.Connect

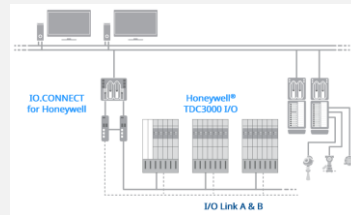

DeltaV HCI

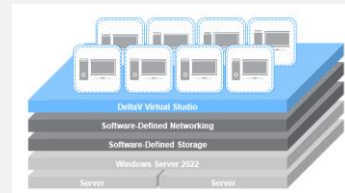

DeltaV PK Flex SW Defined Control

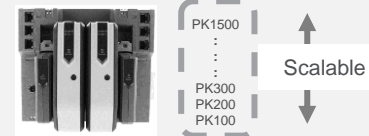

Integrated Eng. Environment

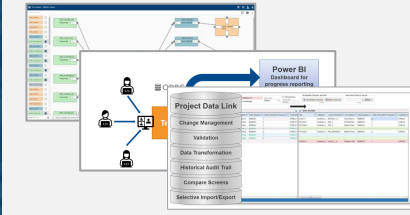

Guardian



AMS Device Manager Data Server

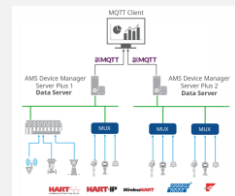

Wireless Connectivity

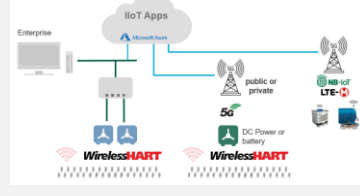

DeltaV Edge Environment



Ovation Grid Edge

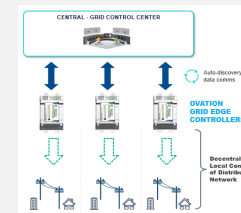

DeltaV Revamp

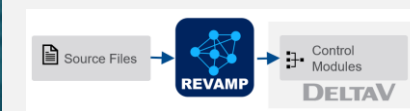

Native AI Tools & Workflows



Software-Defined, Data-Centric and Flexible Automation Platform

Intelligent Field Innovations

Expanding connectivity between sensors and applications



- ✓ Streamlines connectivity
- ✓ Reduces installation cost
- ✓ Installs easily on running processes
- ✓ Seamless addition of new measurements
- ✓ Simplifies integration

Released
October 2022

DeltaV IO.Connect

Reduces DCS modernization cost, complexity and time

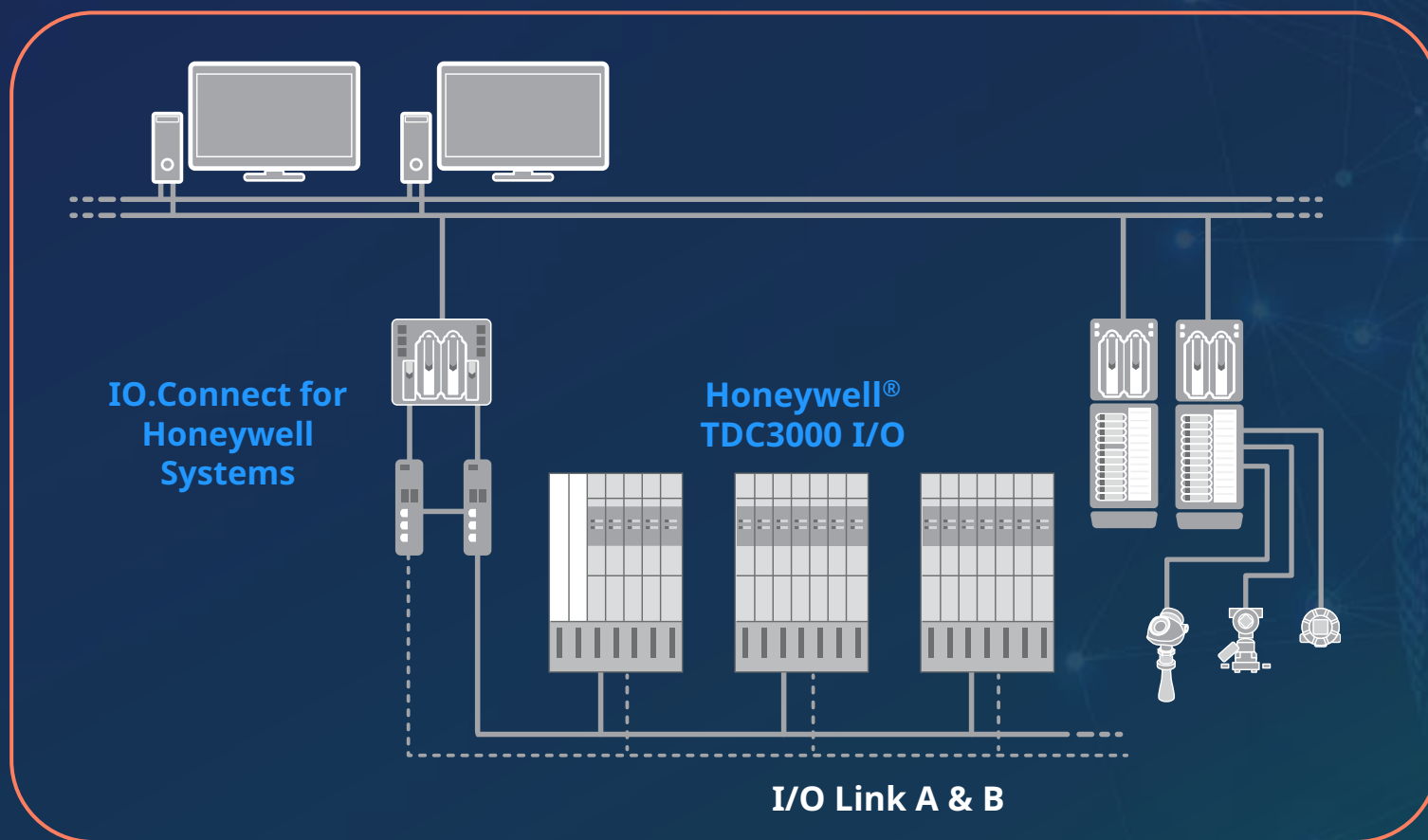

Introduces 3rd Party I/O as DeltaV native

Reduces modernization capital spend by 40%

Up to 90% reduction in schedule by preserving I/O connections

Simple, fast transition to DeltaV control and software

Future-proof operations with flexibility to update I/O opportunistically

Flexible subscription

Up to 90% reduction in schedule by preserving I/O connections Introduces third-party I/O as DeltaV native

Modernization projects are underway!

Chemical Customer, Mexico

- Upgrading TDC3000 system with five controllers to DeltaV
- Startup on track for December

Released
September 2023

Native PROFINET and APL on DeltaV PK Controller

Promoting a flexible approach for I/O integration and communications

- Supports up to 250 devices
- Simplified installation
- Star, MRP ring, hybrid and APL networks
- Seamless connectivity with AMS (coming soon)
- Support for S2 redundancy (coming soon)
- Mix and match device types in one control strategy

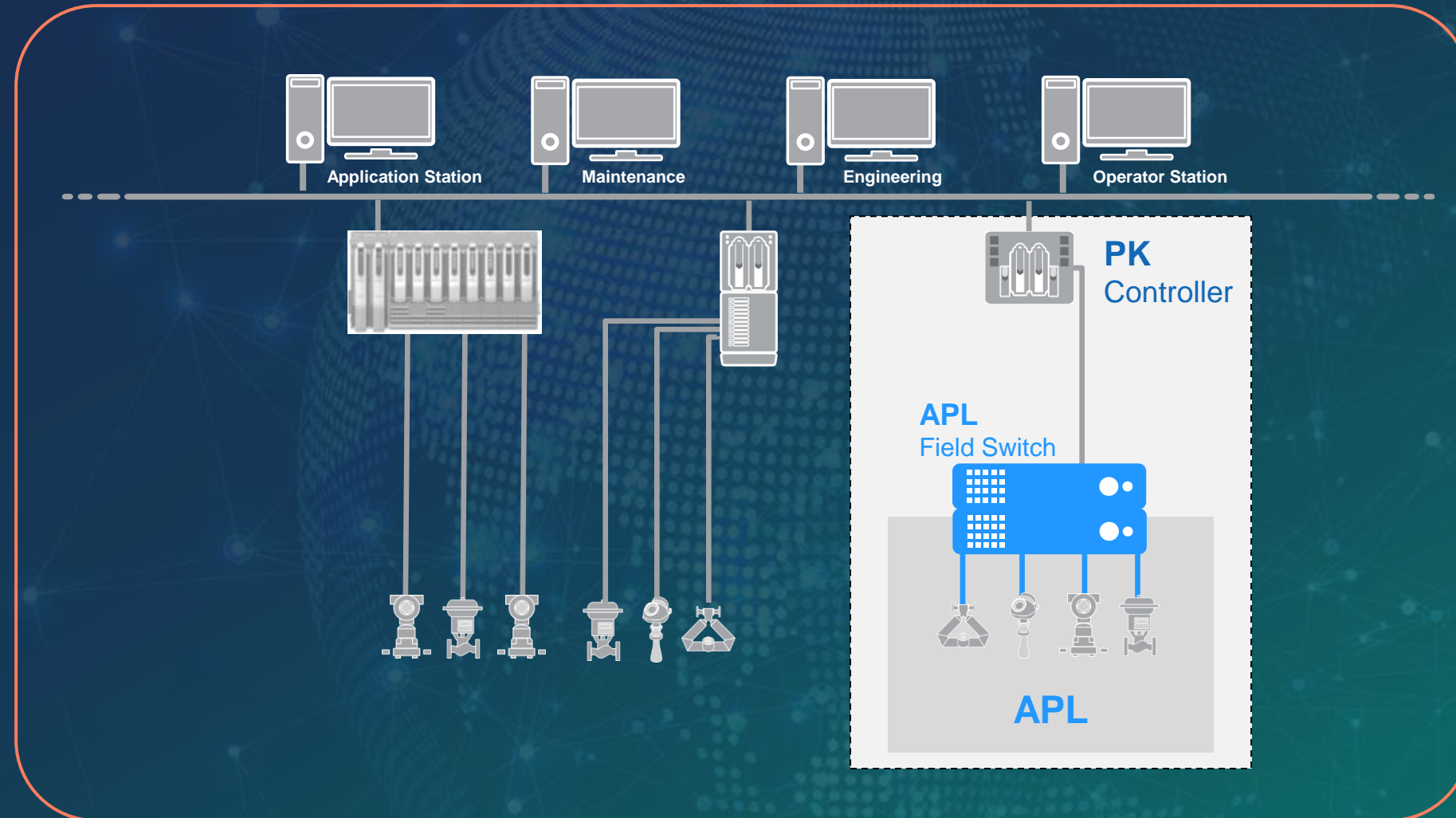

Native integration of PROFINET, Modbus TCP, OPC UA and EtherNet/IP on every DeltaV PK Controller

AMS Device Manager Data Server

Digital enablement tool for intelligent field devices

- Replicate AMS data outside the process control network
- Integration with other data sources for advanced analytics and machine learning
- Continuous, automated collection of field device information
- Centralized management program with a secure infrastructure
- Instrument diagnostics enabled early detection of underperforming equipment

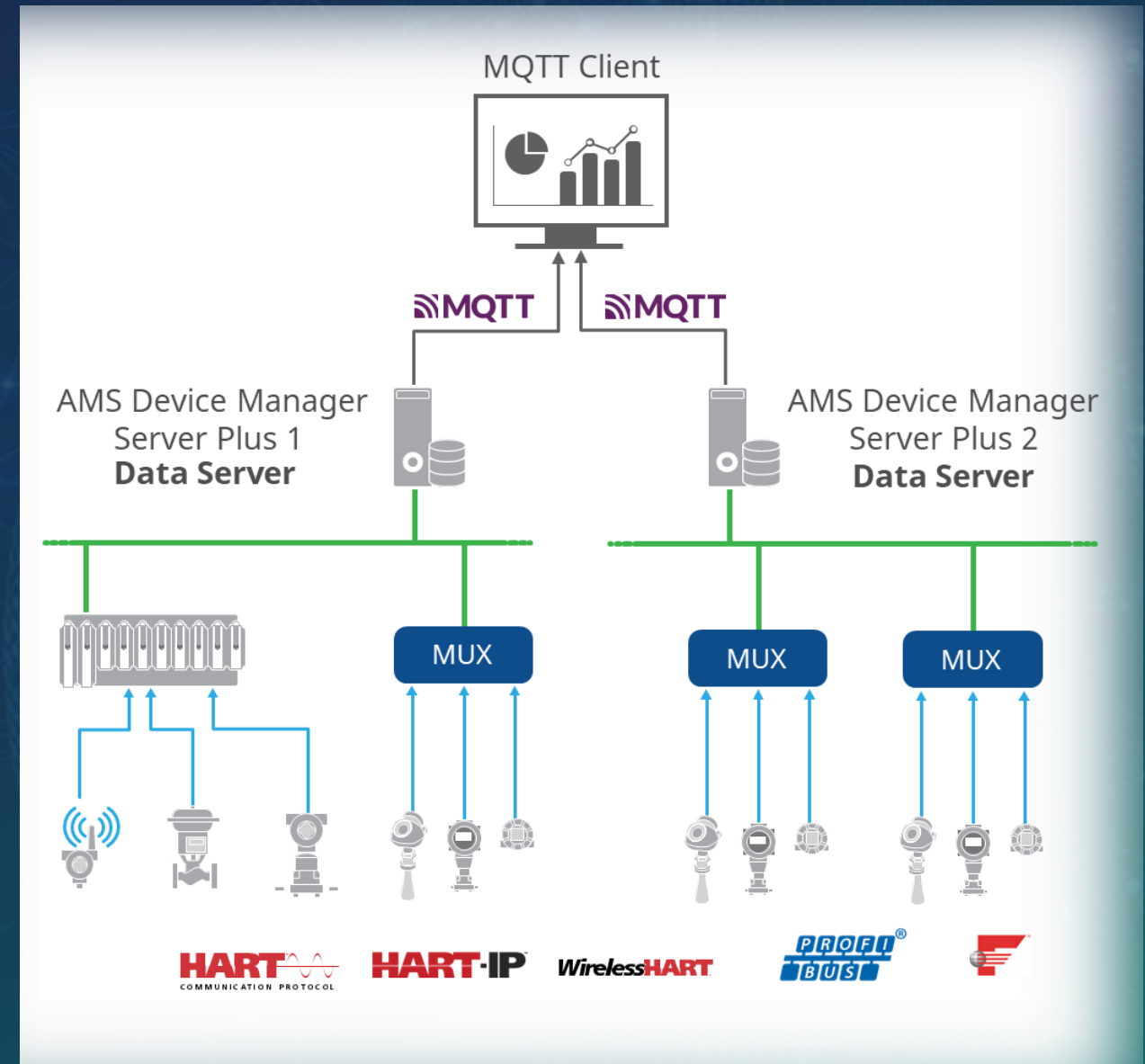

Connect data from intelligent field to any application, simplifying maintenance, reducing complexity and democratizing data

Wireless Devices

Easy drop-in data for pervasive monitoring

- ✓ Increased density
- ✓ Longer range
- ✓ Reduced cost
- ✓ Geographically dispersed
- ✓ Communicate anywhere
- ✓ Rugged solutions

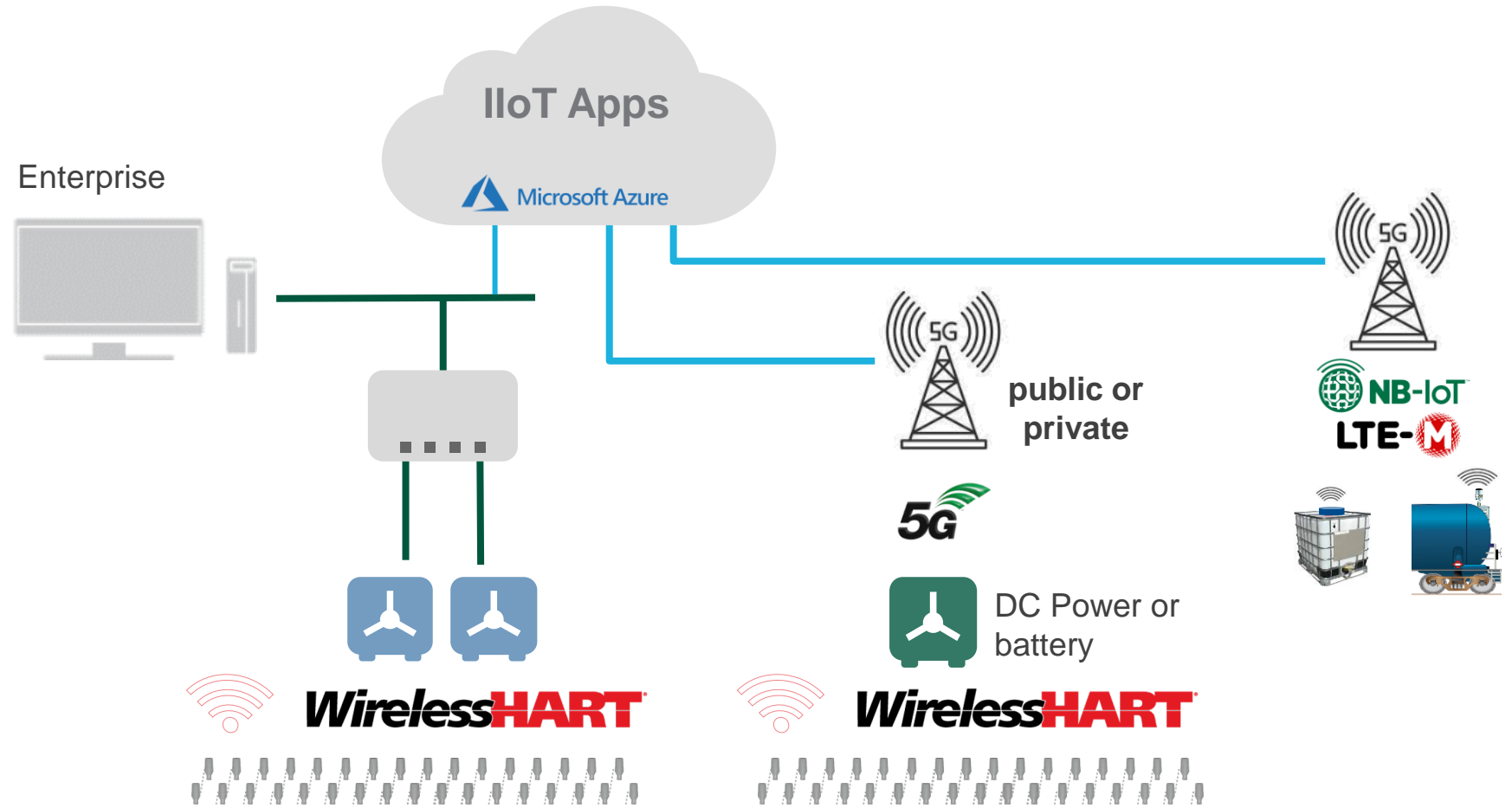

5G brings flexible, secure connectivity to the entire enterprise, from high density facilities to mobile single assets

Edge Innovations

Where IT and OT innovation come together

- Simplifies networking
- Enhances security
- Democratizes data
- Accelerates co-creation
- Better aligns IT and OT
- Improves robustness

Hyperconverged Infrastructure (HCI)-Based Virtualization

Easy, scalable virtualization with improved performance

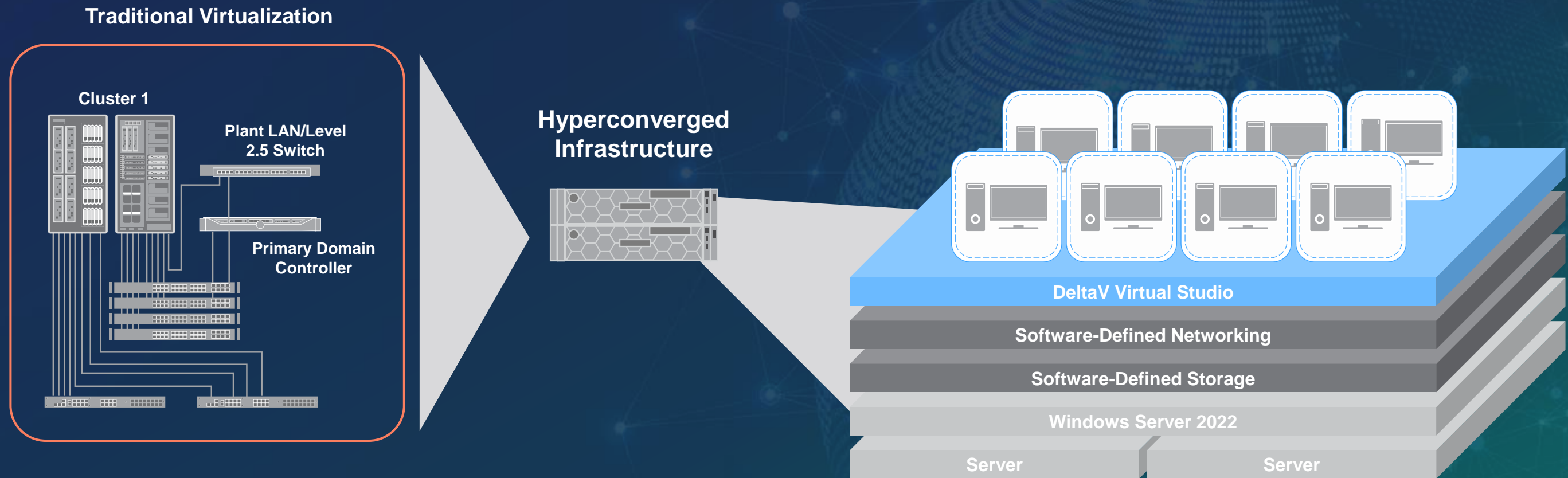

- 50% reduction in deployment time
- Easy to expand, upgrade and maintain
- 20%+ performance improvement
- Reduced energy use and footprint

Options with two, three or four servers

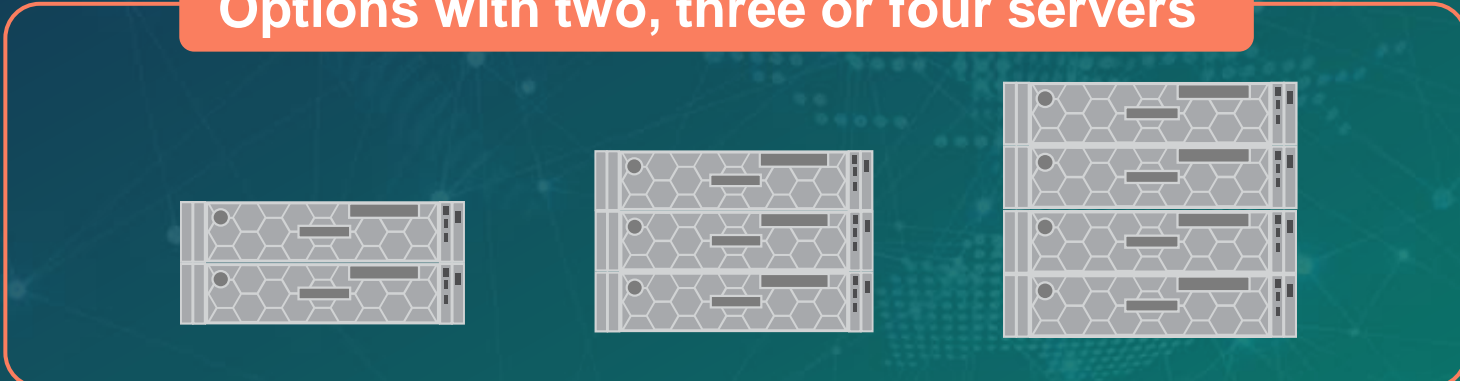

Software Defined Control

Evolving towards a software-defined system with reduced footprint and easier upgrades

DeltaV DCS

PK Flex

- Software-scalable PK
- Flexible subscription-based licensing
- Decouples HW and SW

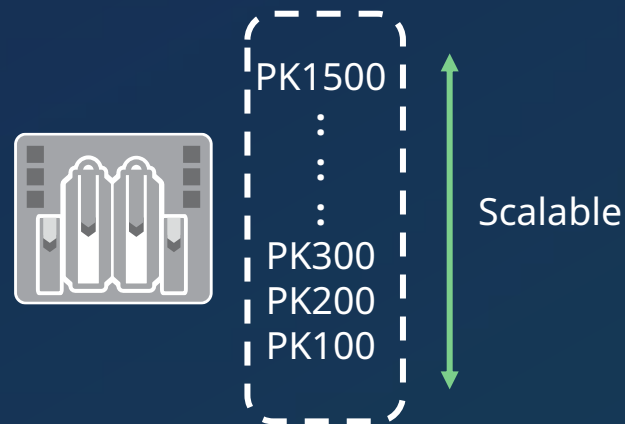

Released September 2023

DeltaV DCS

Software defined controller

Control for process and hybrid industries

Release Next 12 Months

Deployed on HCI hardware

High-availability

Subscription-based licensing

Hardware independent

Ovation DCS

Software defined controller

Control for power and water industries

Release Q2 2024

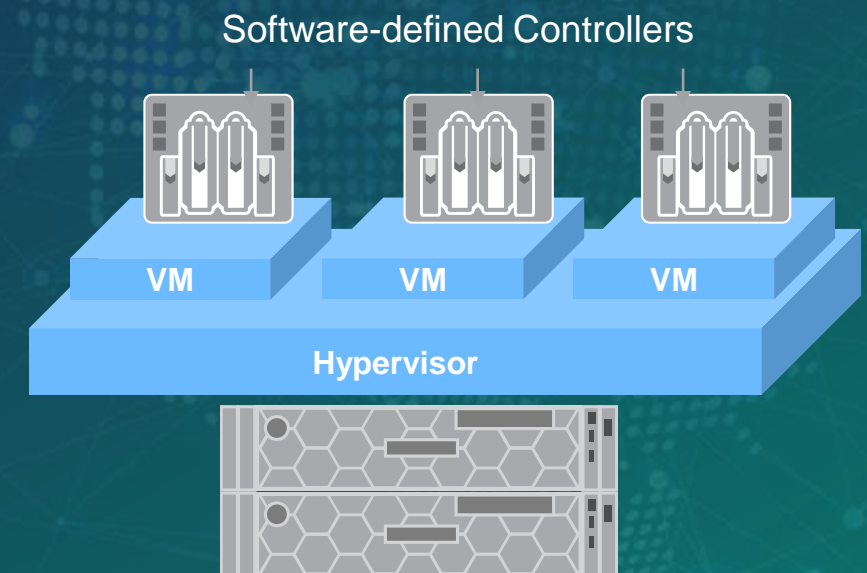

Integration with AspenTech Solutions

Optimizing production and driving operational excellence

Coming Soon

- Integration of AspenTech's Historian, advanced control and analytics platforms
- Fast and easy deployment with DeltaV
- Scalability and expanded data sources and interfaces with IP.21 Historian

Driving synergies between Emerson and AspenTech portfolios to improve operations

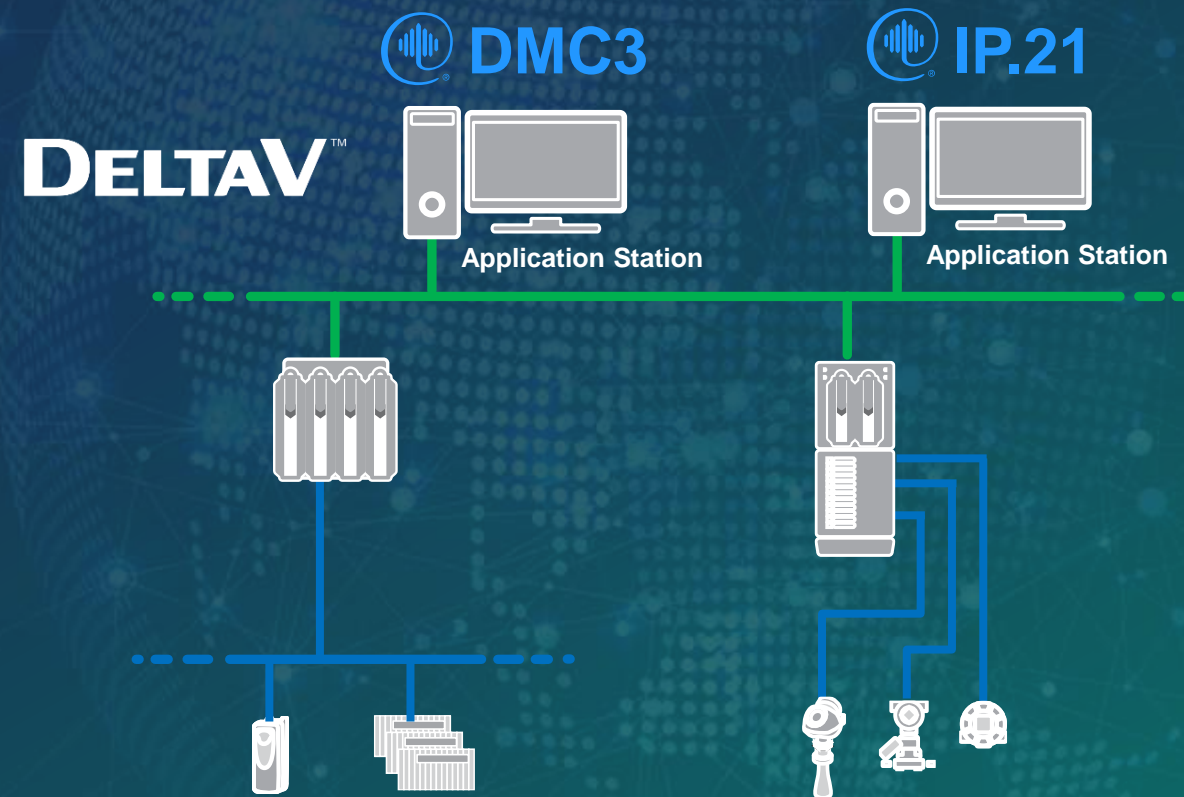

DeltaV Edge Environment

Enhanced OT connectivity and runtime capabilities

- DeltaV DCS runtime and configuration data
- Up to 300K parameters
- Bridges IT and OT technologies and policies
- Remote centralized fleet management

Release
October 2023

Management Functions



Local Access



Connectivity

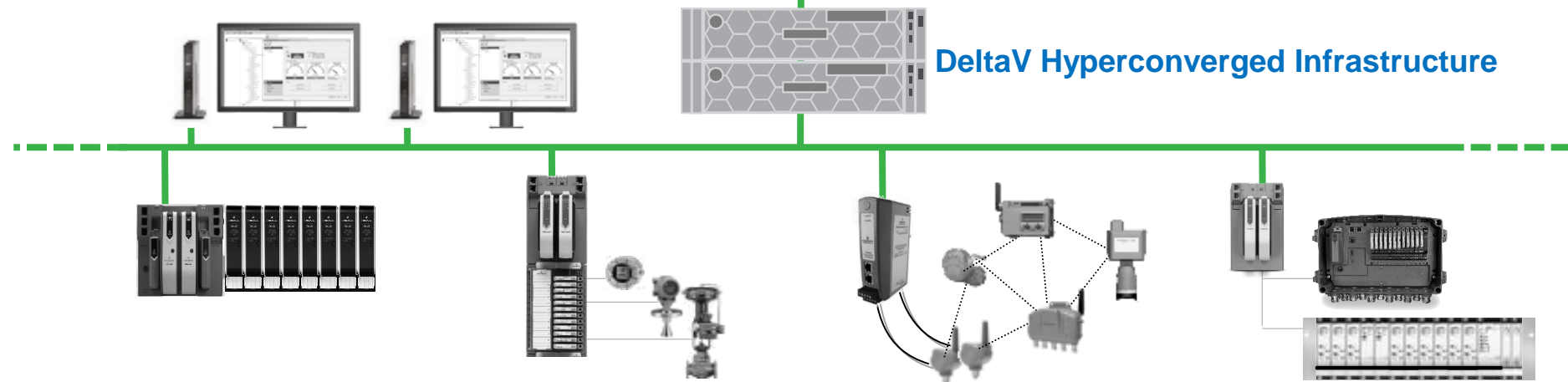
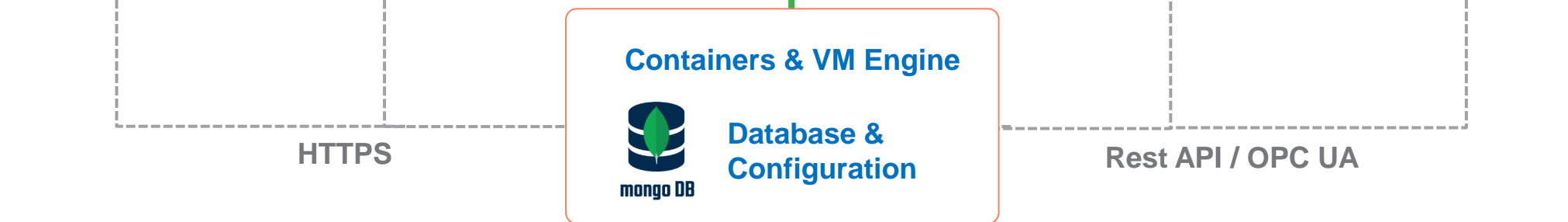

Ovation Grid Edge

Innovative distributed grid solutions are critical to achieving decarbonization goals

Customer Challenges

- Increasing demand and loads
- User generation flow
- New bidirectional communication
- More types of connected devices

Emerson's Solution

- Real-time, high-resolution grid data
- Combines field device, control system and grid management
- Manages bidirectional flow

Customer Value

- Provides clear operational visibility
- Empowers teams to optimize operations across the grid
- Improves load and demand management

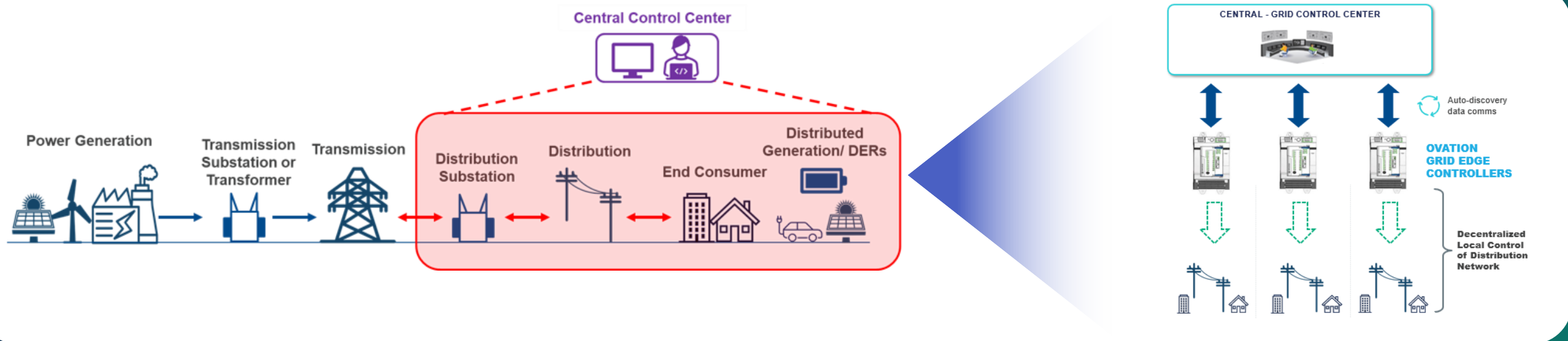

Cloud Innovations

Creating a connected enterprise platform



- Fleet management
- Collaboration
- Lower up-front costs
- Easy deployment
- Limitless scalability
- Centralized security management

Integrated Engineering Environment (IEE)

Leveraging cloud for improved project engineering

Increased quality

Easier acceptance of late changes

Improved project speed and efficiency

Seamless collaboration

Data sharing between disciplines

Secure by design

E&I Studio

Browser-based I/O configuration

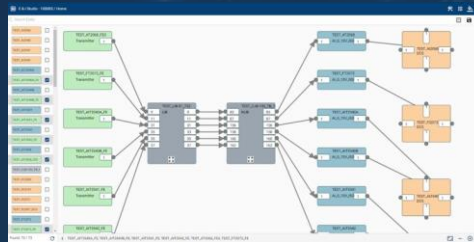

Sequence Studio

Automated sequence data and configuration management



Project Data Link

Common single instance of project data and configuration generation

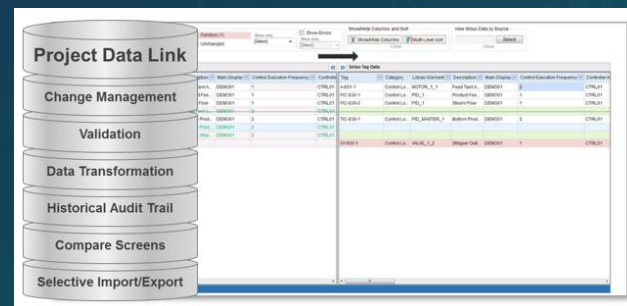

Test Studio

Enables remote FATs and digitized test management

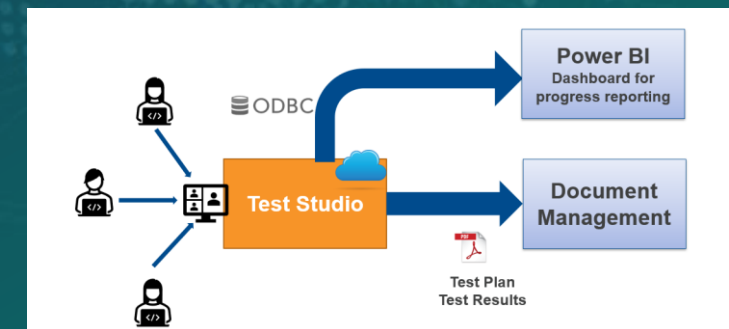

Guardian

Software and subscription lifecycle management and support

Single sign-on (SSO)

Software downloads

Subscription management

Personalized and enterprise dashboards

AI-powered search and recommendations



Product Support

Subscription Management

Lifecycle Software and Services

AI Will Unleash Augmented Tools and Workflows

Enhance productivity and improve situational awareness

**LOGIC
GENERATOR**



**I/O
CONFIGURATION**

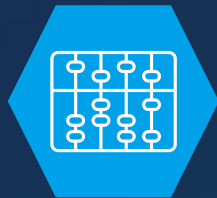

**HMI DISPLAY
GENERATOR**



**OPERATOR
COPILOT**



**KNOWLEDGE BASE
CURATOR**



**CALL UP
ASSISTANT**



DeltaV Revamp

Cloud-based modernization of legacy DCS, PLC, and safety systems to DeltaV

- Generative AI copilot for project teams
- Near-instant analysis of project scope
- Automated migration of base layer of control
- Machine learning generated rules and recommendations
- Reduced risk and capital costs
- Improved schedule and efficiency

Fully integrated digital workflow leveraging the power of artificial intelligence

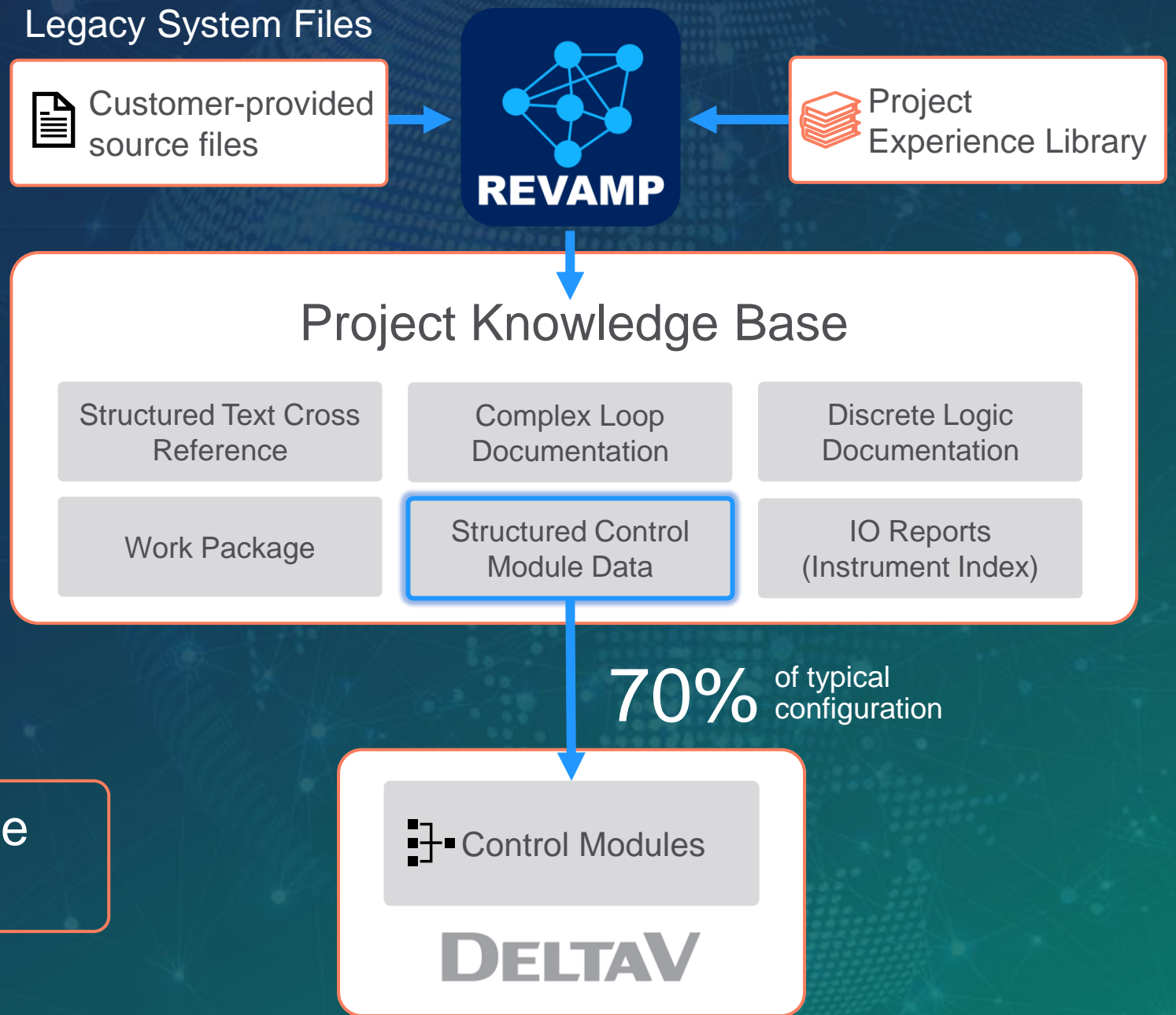

Zero-trust OT Security

Security assumes network has been compromised

Access control enforcement is as granular as possible

No user or asset is to be implicitly trusted

Identity, context, and data-centric approach

Minimize uncertainty in enforcing access decisions

Working with partners to create Zero-trust for OT framework

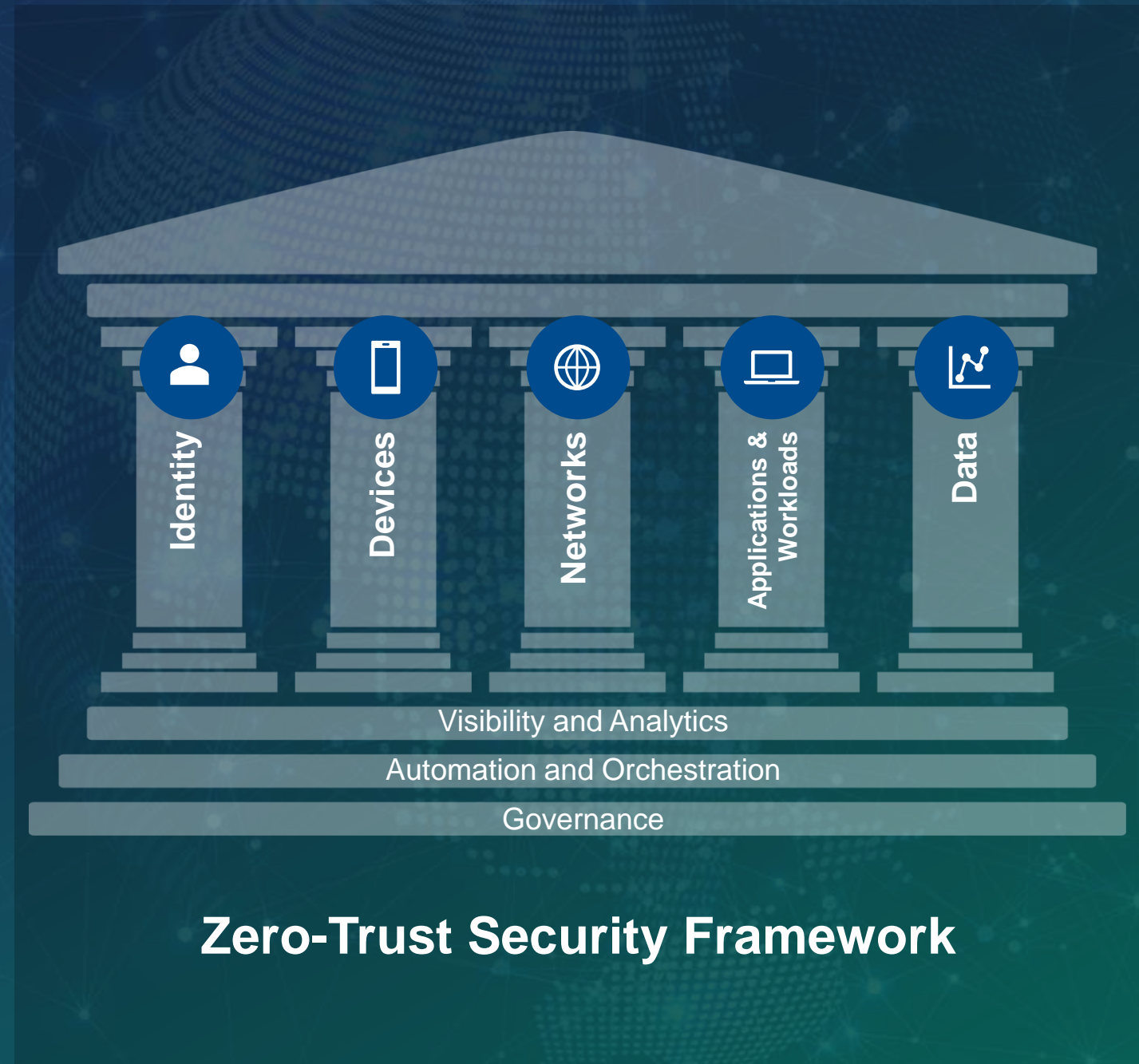

Cohesive Software Innovations

Delivers value across the automation platform



- Unified data model
- Published APIs
- Multi-vendor interoperability
- Integrated standards
- Secure by design
- Delivering quantifiable value to end users

DeltaV Data Democratization

Secure sandbox for business and operational dashboards

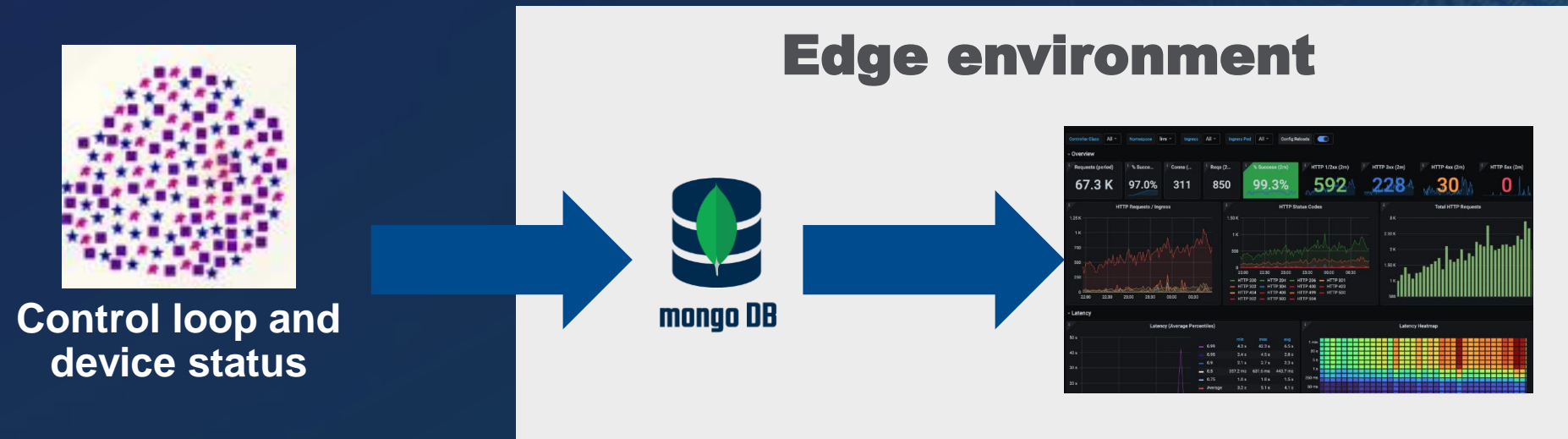

Numerous Use Cases

Real-time views for people to have access outside the plant

AI training mechanisms

Reporting and optimization

Report comparing different config versions

AI-driven process analytics and optimization

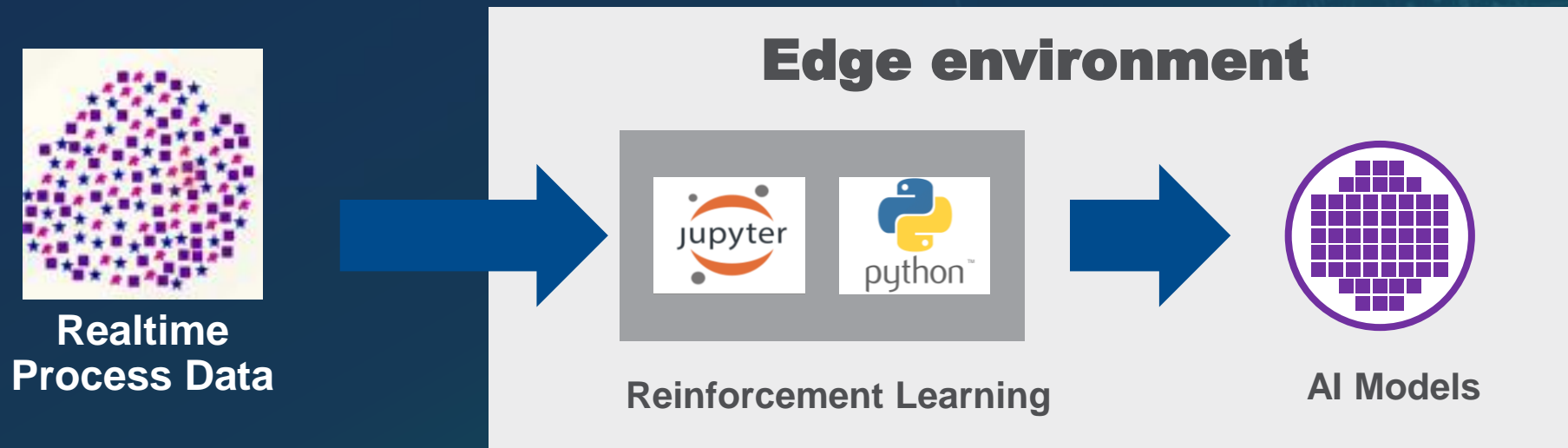

Ovation Green Renewable Energy Automation Software & Solutions

Optimize annual energy production and deliver low-cost clean energy

Released
February 2023

Helps power producers build and scale sustainable operations

Provides greater operational visibility driving faster, more informed decisions

Increases reliability and availability

Reduces operations and maintenance costs

Leverages industry-leading Ovation automation platform, deep expertise in power and renewable industry from a trusted partner

OVATION™ GREEN



Asset Management



Wind Solutions



Solar Solutions



Battery Solutions



Microgrid – DERMS Solutions



Hydro Solutions



Green Hydrogen Solutions



Biomass Solutions



Geothermal Solutions



Hybrid Renewable Solutions

2023
FROST & SULLIVAN
ENABLING TECHNOLOGY LEADERSHIP AWARD

Identified as best in class in the global power and energy automation industry



Machinery and Automation Asset Management

AMS NextGen Drives Improved Work Practices with AspenTech Mtell

Software-as-a-Service option

Cloud-enabled deployment

Insights across the enterprise

Integrated dashboard and reports

Enhanced connectivity through modern protocols

Automated analysis of 1000's of assets using machine learning, *failure patterns*, *bad actors*

Analytics-driven work management

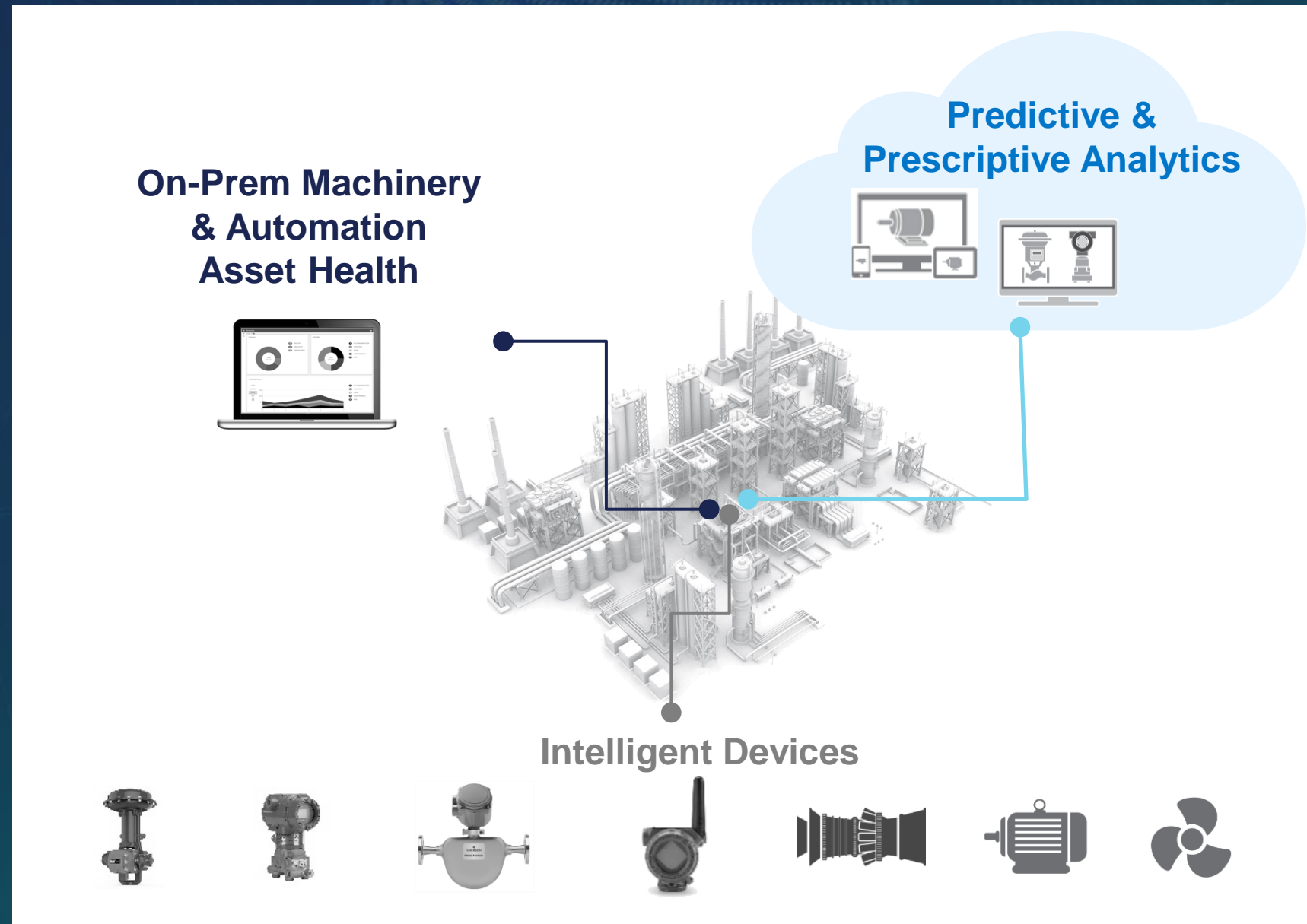

DeltaV Workflow Studio Speeds Time to Market for Personalized Medicine

Release
January 2024

DeltaV Workflow Studio

Recipe authoring, execution,
and electronic data capture

Simple & Flexible

*Recipes can be authored by
scientists and modified quickly*

SaaS

*Can be adopted without a large
IT department*

Cloud-Based

*Does not require significant capital
investment in hardware*

Validation Ready

*Supports customers' GxP
compliance*

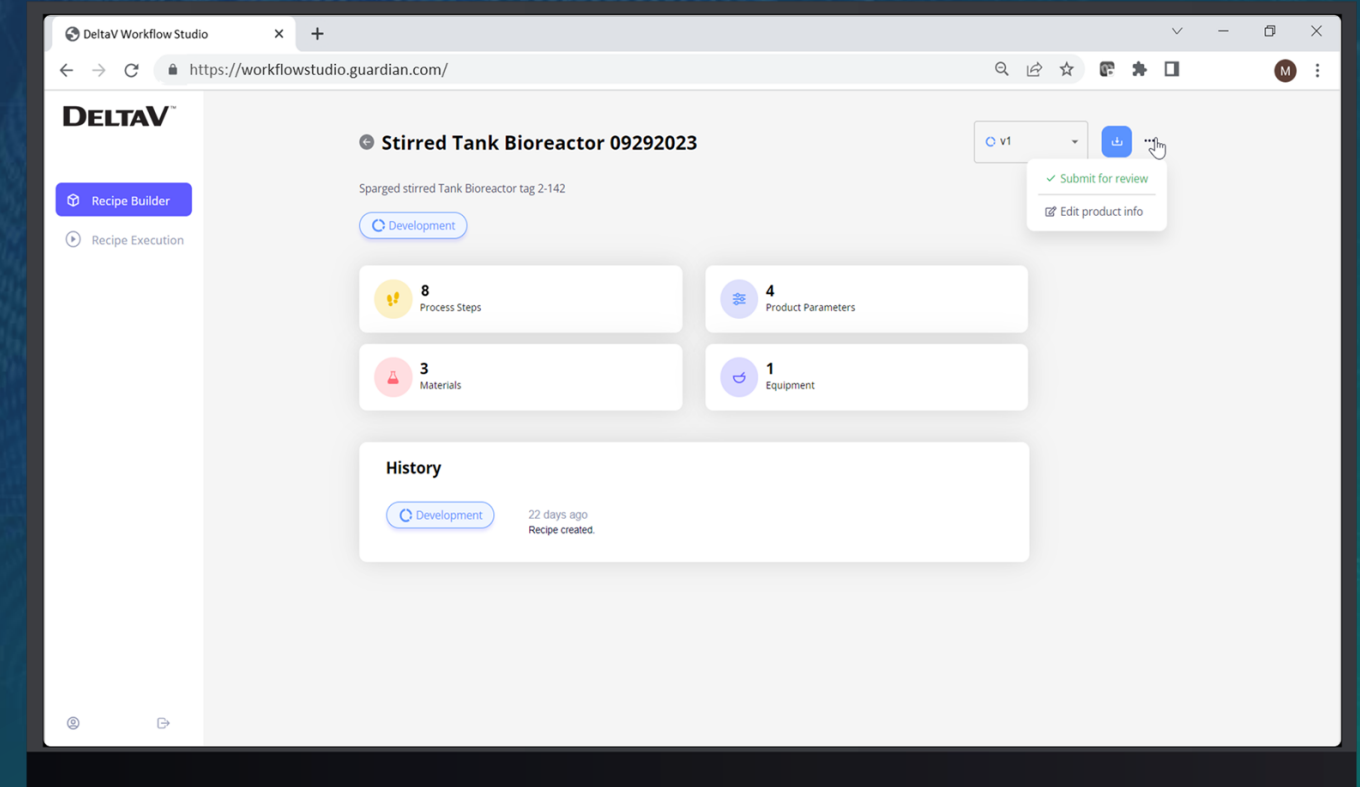
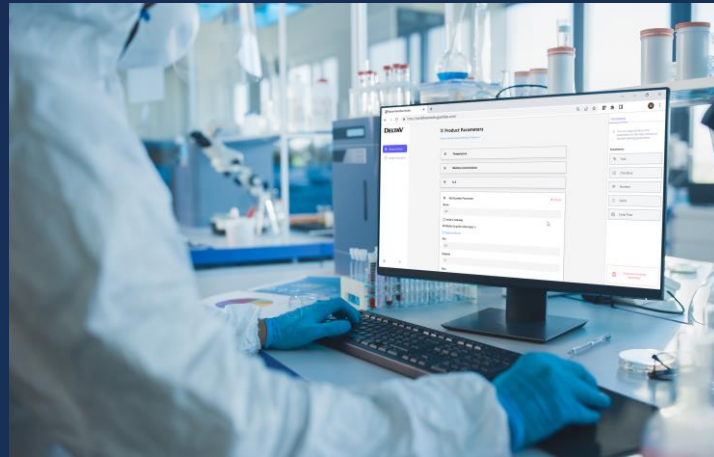

Digital Recipe Lifecycle Management Significantly Accelerates Tech Transfers

Challenges Managing the Recipe Lifecycle

- Paper documents, spreadsheets, meeting minutes
- Siloed, disconnected recipe specifications
- Manual translation between phases/organizations
- No industry standards for recipe plug-and-play

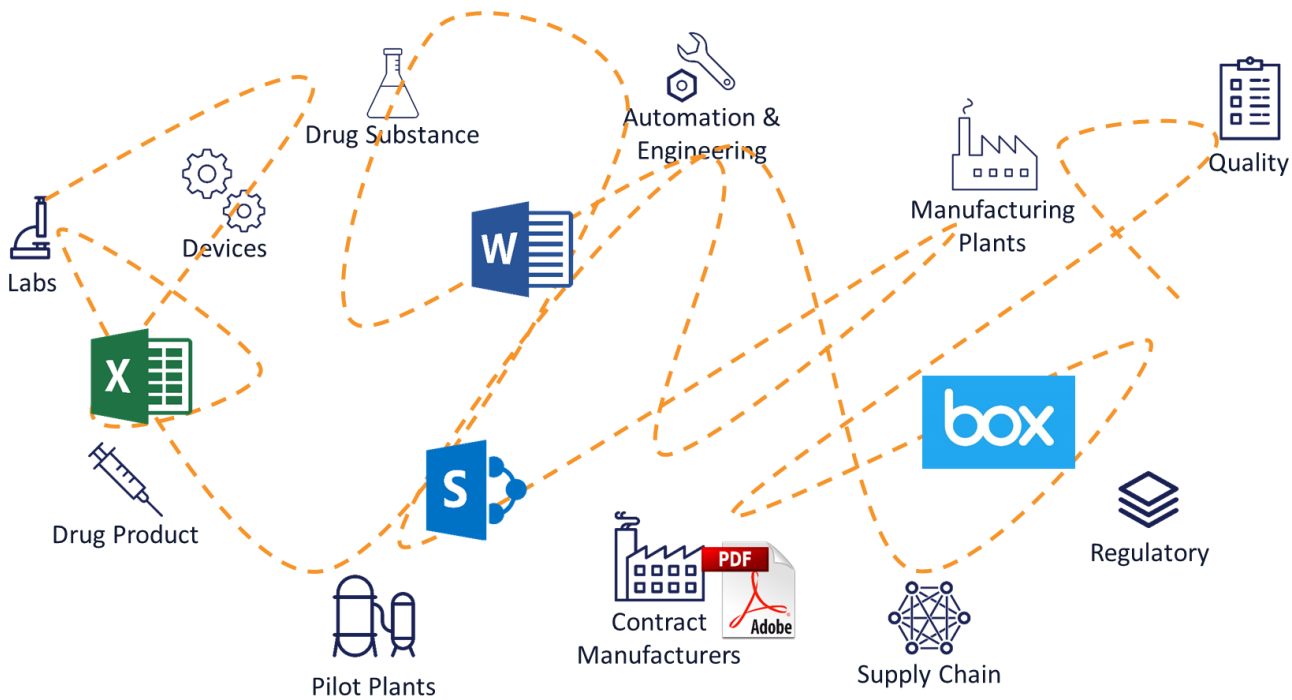

New Vision: Digital Recipe Lifecycle Management

- Enhances data integrity
- Improves productivity
- Eliminates data translations across functional groups
- Single source of truth across entire lifecycle

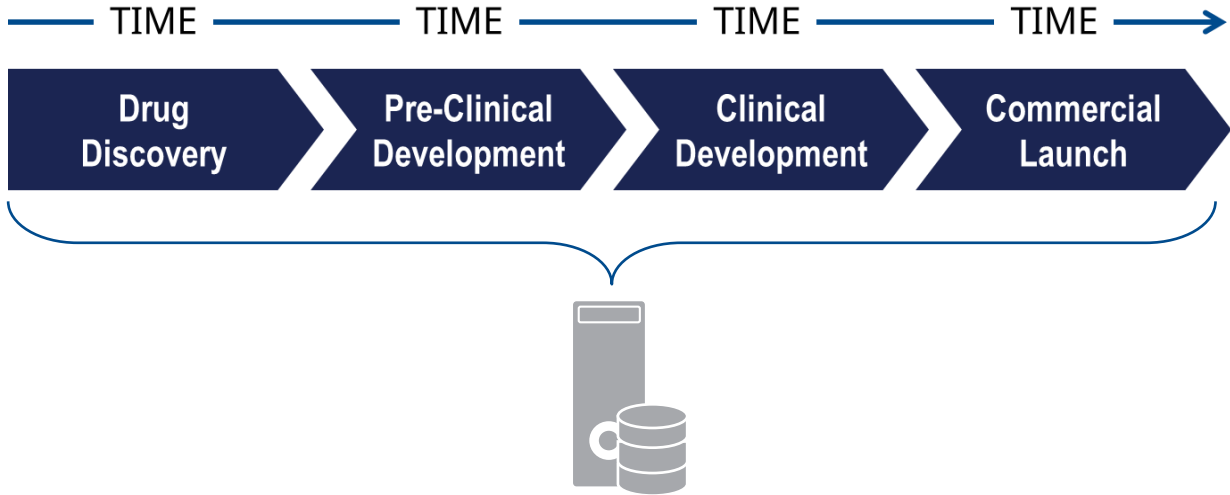

Industry Stewardship

One-Click Tech Transfer™ Board

“The generations of life sciences expertise in the current partners of the One-Click Technology Transfer Executive Board will help ensure successful digitalization solutions also promote scalability, standardization and best practices as they influence the coming decades of life sciences innovation and benefits for patients,” said Lars Petersen, president and CEO of Fujifilm Diosynth.

Industry Innovators

MERCK Pfizer FUJIFILM
+ Others TBA Diosynth biotechnologies

Technology Leader

EMERSON

Singapore-based team funded by EDB (Economic Development Board)

Standardization

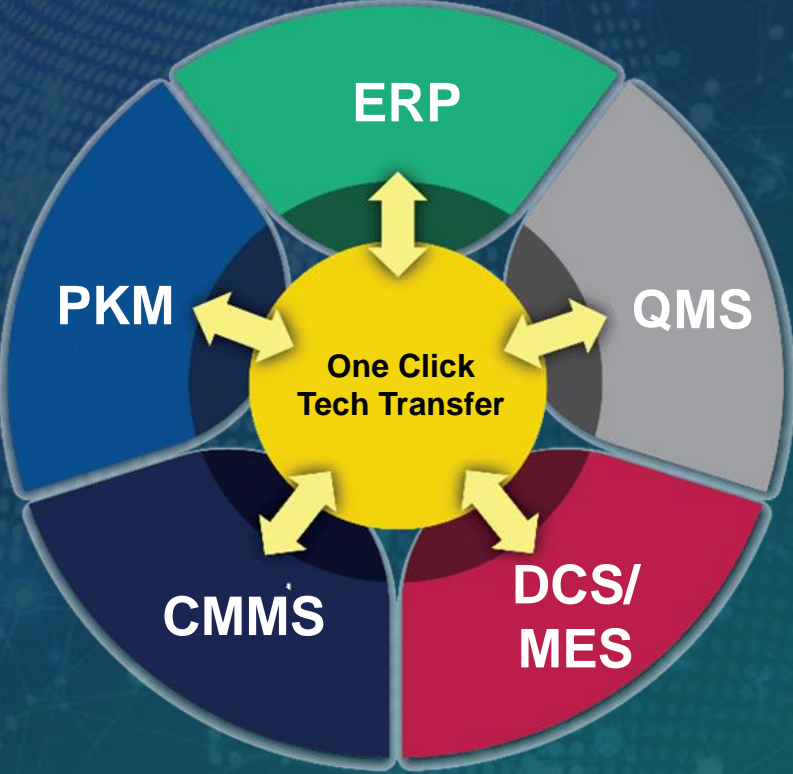

“Our vision is to move from document driven processes to data driven processes to accelerate our new product launch and technology transfer,” said Mike Tomasco, vice president of Pfizer Digital Manufacturing.

Boundless Automation Unleashed

Transforming the automation industry... again

Software-Defined | Data-Centric | Flexible

Automation Platform

Q & A Session

You have questions. We have answers.

A Few Reminders

Tuesday Oct. 3

- 5-6:30 p.m. – Media & Analysts Cocktail Reception – Meet many of Emerson’s experts in a casual setting, Marriott, nFuse Restaurant

Wednesday Oct. 4

- 8-9:00 a.m. – **General Session** – Anaheim Convention Center, Hall A
- 10-11:30 a.m. – **Media & Analysts Private Theatre tour and Key Exhibits**, North Level 100 **Meet at the escalators on the main plaza outside of exhibit hall @9:50**

Thursday Oct. 5

- 11:30-1 p.m. – **Lunch Program Automation & Sustainability**, Anaheim Convention Center, Hall A



Download the Media Kit by scanning QR Code

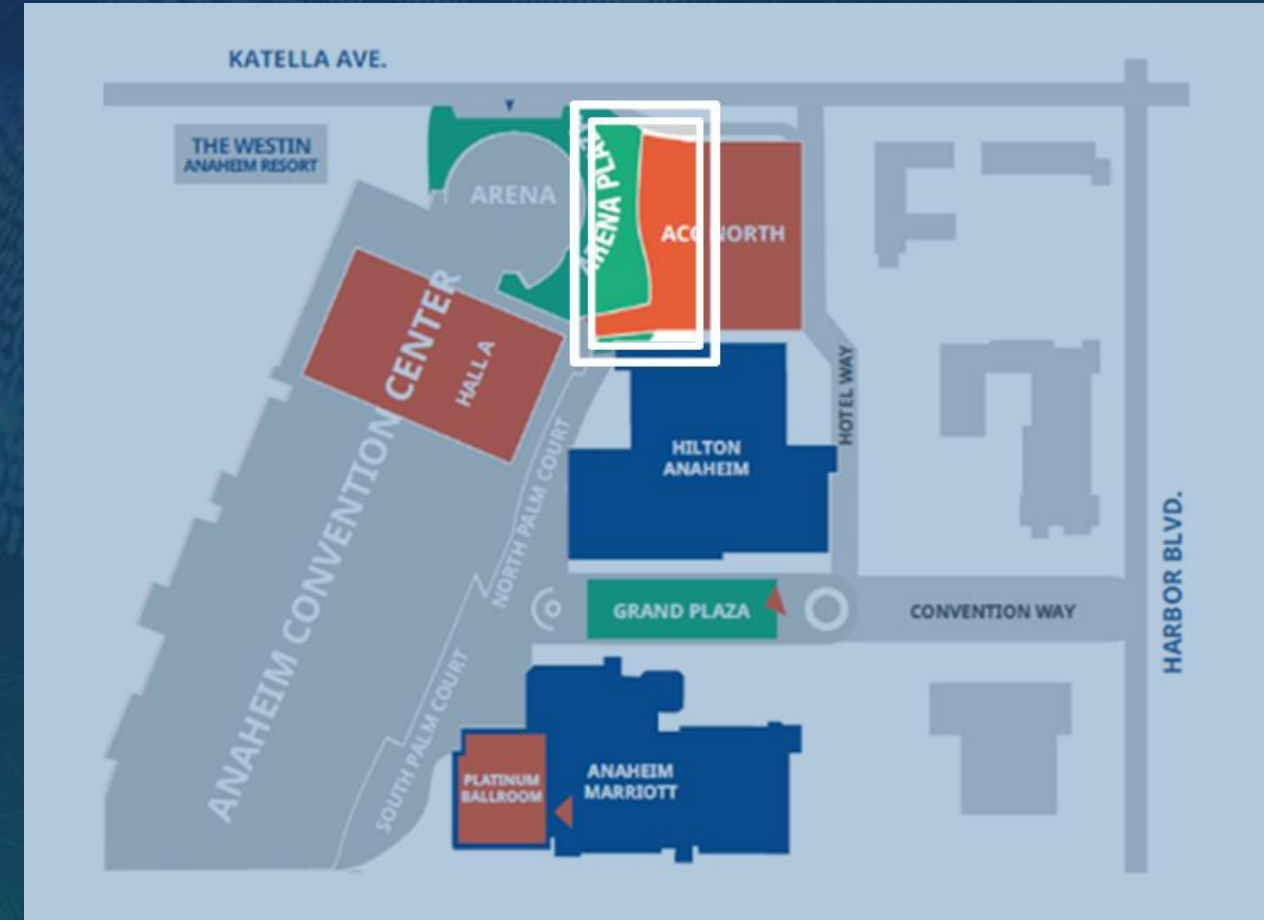

Download the App by scanning QR Code